

DIXIT RA20 RECESSED

A56015-

base number _____ Color _____
Temperature _____

1. To build a product code in our configurator select the specify button on the base model # product page
2. To build a manual product code on this datasheet choose from the options listed below in blue font and add the suffix to the base model #

GENERAL

Series: Dixit
Subseries: Dixit RA20
Brand: Ivela
Division: Architectural
Mounting Type: Recessed
Mounting Location: Ceiling
Subcategory: Downlight

PHYSICAL

Shape: Round
Diameter (mm): 200
Diameter (in): 7 7/8
Height (mm): 95
Height (in): 3 3/4
Min. Recessing Depth (mm): 143
Min. Recessing Depth (in): 5 5/8
Light Distribution: Direct
Weight (kg): 1.8
Weight (lbs): 3.97
Diffuser: Clear Polycarbonate
Fixture Finish: MWH
Fixture Material: Aluminum Die Cast
Cut-out Measurements: 185mm / 7 9/32"

ELECTRICAL

Lamp Type: LED
Total Output Wattage (W): 51
Dimming: Tri-Mode (Non-Dimming and Phase Dimming (120Vac only) and 0-10V Dimming)
Driver Included: No
Driver Location: Recessed Housing
Driver Type: Constant Current - Universal
Driver Class: Class 2
Housing: See Components
Input Voltage (V): 120 - 277
Constant Current (MA): 1400

LED

Number of LEDs: 1
Color Temperature (°K): 2700 / 3000 / 4000
Max. Delivered Lumen (lm): 5375 / 5485 / 5656
CRI: >85 CRI
Efficiency (%): 85.7
Lamp Life (hrs): 50000
Upon Request: 3500K upon request

OPTICAL

Optic°: 100

RATINGS AND CERTIFICATIONS

Certified By: CSA Certified to UL and CSA Standards
IP rating: IP44
IK Rating: IK07



DIXIT RA20 RECESSED

A56015-

| | |
|-----------|--|
| PROJECT | |
| TYPE | |
| SPECIFIER | |
| QUANTITY | |
| DATE | |

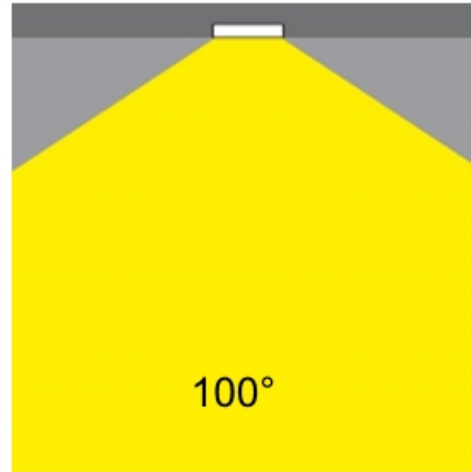
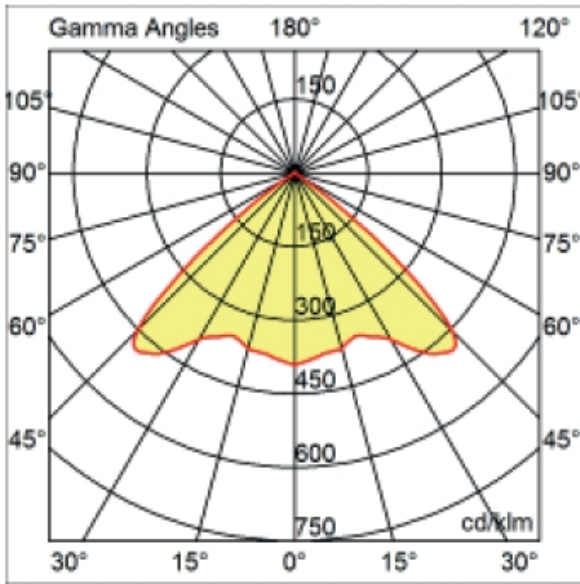

| | | | | |
|-------------------|--------------|--------------|--------------|--------------|
| | DP | DV | | |
| Dimming | Phase | 0-10V | | |
| Color Temperature | 27K 2700K | 30K 3000K | 35K 3500K | 40K 4000K |

Order Example  **K°**
L5XXXXXX-DV-30K
 0-10V
 3000K



DIXIT RA11 RECESSED

A56020-

base number _____
 Color _____
 Temperature _____

| | |
|-----------|-------|
| PROJECT | _____ |
| TYPE | _____ |
| SPECIFIER | _____ |
| QUANTITY | _____ |
| DATE | _____ |

- To build a product code in our configurator select the specify button on the base model # product page
- To build a manual product code on this datasheet choose from the options listed below in blue font and add the suffix to the base model #

GENERAL

Series: Dixit
 Subseries: Dixit RA11
 Brand: Ivela
 Division: Architectural
 Mounting Type: Recessed
 Mounting Location: Ceiling
 Subcategory: Downlight

PHYSICAL

Shape: Round
 Diameter (mm): 110
 Diameter (in): 4 ⁵/₁₆
 Height (mm): 70
 Height (in): 2 ⁷/₁₆
 Min. Recessing Depth (mm): 110
 Min. Recessing Depth (in): 4 ¹⁵/₁₆
 Light Distribution: Direct
 Weight (kg): 0.6
 Weight (lbs): 1.32
 Diffuser: Clear Polycarbonate
 Fixture Finish: MWH
 Fixture Material: Aluminum Die Cast
 Cut-out Measurements: 100mm / 3 15/16"

ELECTRICAL

Lamp Type: LED
 Total Output Wattage (W): 12 / 18 / 26
 Dimming: Tri-Mode (Non-Dimming and Phase Dimming (120Vac only) and 0-10V Dimming)
 Driver Included: No
 Driver Location: Recessed Housing
 Driver Type: Constant Current - Universal
 Driver Class: Class 2
 Input Voltage (V): 120 - 277
 Constant Current (MA): 350 / 500 / 700

LED

Number of LEDs: 1
 Color Temperature (°K): 2700 / 3000 / 4000
 Max. Delivered Lumen (lm): 1513 / 2092 / 2759
 CRI: >85 CRI
 Efficiency (%): 89
 Lamp Life (hrs): 50000
 Upon Request: 3500K upon request

OPTICAL

Optic°: 55
 Adjustability: Fixed
 Upon Request: Optic 18° or 30° (mirror-metallized) / 70° (white)

RATINGS AND CERTIFICATIONS

Certified By: Certified for North American Standards
 IP rating: IP43
 IK Rating: IK08
 Glare Rating: ≤ 19

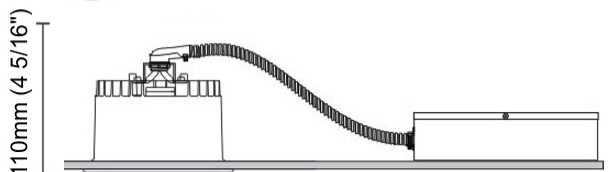
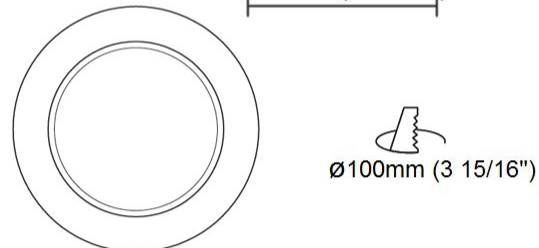
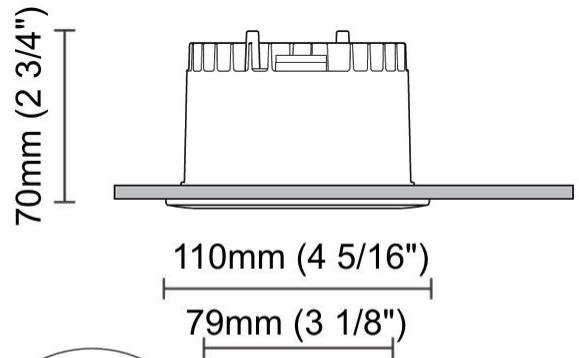

DIXIT RA11 RECESSED

A56020-

| | |
|-----------|--|
| PROJECT | |
| TYPE | |
| SPECIFIER | |
| QUANTITY | |
| DATE | |

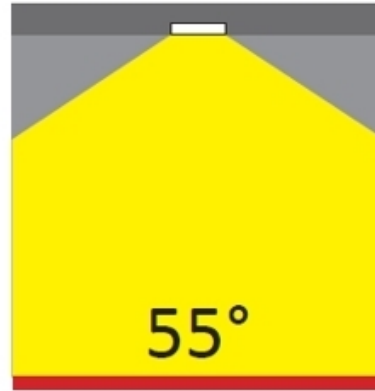
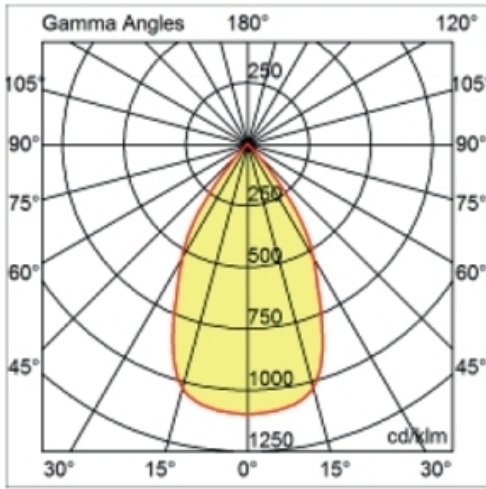

| RA 11 DIXIT LED 12W 1700LM 3000K | | | | R:100% | | I.Max:1096 Cd/Klm | | | | | |
|----------------------------------|------|---------|---------|-----------|------|-------------------|------|---------|---------|----------|--|
| H[m] | D[m] | Max lux | Med lux | Alpha=55° | | H[m] | D[m] | Max lux | Med lux | Beta=55° | |
| 1.00 | 1.13 | 1658 | 898 | | | 1.00 | 1.13 | 1658 | 898 | | |
| 2.00 | 2.26 | 415 | 224 | | 2.00 | 2.26 | 415 | 224 | | | |
| 3.00 | 3.38 | 184 | 100 | | 3.00 | 3.38 | 184 | 100 | | | |
| 4.00 | 4.51 | 104 | 56 | | 4.00 | 4.51 | 104 | 56 | | | |
| 5.00 | 5.64 | 66 | 36 | | 5.00 | 5.64 | 66 | 36 | | | |

| | | | |
|-------------------|-----------------|-------------------------|----|
| | DP | DV | |
| Dimming | Phase | 0-10V | |
| Color Temperature | 27K 30K 35K 40K | 2700K 3000K 3500K 4000K | K° |

Order Example **L5XXXXXX-DV-30K**

0-10V **3000K**



DIXIT RA11 RECESSED

A56024-

base number Color
Temperature

- To build a product code in our configurator select the specify button on the base model # product page
- To build a manual product code on this datasheet choose from the options listed below in blue font and add the suffix to the base model #

GENERAL

Series: Dixit
 Subseries: Dixit RA11
 Brand: Ivela
 Division: Architectural
 Mounting Type: Recessed
 Mounting Location: Ceiling
 Subcategory: Downlight

PHYSICAL

Shape: Round
 Diameter (mm): 125
 Diameter (in): 4 ¹⁵/₁₆
 Height (mm): 79
 Height (in): 3 ¹/₈
 Min. Recessing Depth (mm): 119
 Min. Recessing Depth (in): 4 ¹¹/₁₆
 Light Distribution: Direct
 Weight (kg): 0.6
 Weight (lbs): 1.32
 Diffuser: Clear Polycarbonate
 Fixture Finish: MWH
 Fixture Material: Aluminum Die Cast
 Cut-out Measurements: 116mm / 4 9/16"

ELECTRICAL

Lamp Type: LED
 Total Output Wattage (W): 12 / 18 / 26
 Dimming: Tri-Mode (Non-Dimming and Phase Dimming (120Vac only) and 0-10V Dimming)
 Driver Included: No
 Driver Location: Recessed Housing
 Driver Type: Constant Current - Universal
 Driver Class: Class 2
 Input Voltage (V): 120 - 277
 Constant Current (MA): 350 / 500 / 700

LED

Number of LEDs: 1
 Color Temperature (°K): 2700 / 3000 / 4000
 Max. Delivered Lumen (lm): 1513 - 1602 / 2092 - 2180 / 2759 - 2848
 CRI: >85 CRI
 Efficiency (%): 89
 Lamp Life (hrs): 50000
 Upon Request: 3500K upon request

OPTICAL

Optic°: 55
 Adjustability: Tilt ±20°
 Upon Request: Optic 18° or 30° (mirror-metallized) / 70° (white)

RATINGS AND CERTIFICATIONS

Certified By: Certified for North American Standards
 IP rating: IP20
 IK Rating: IK08
 Glare Rating: ≤ 19

| |
|-----------|
| PROJECT |
| TYPE |
| SPECIFIER |
| QUANTITY |
| DATE |

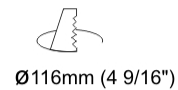
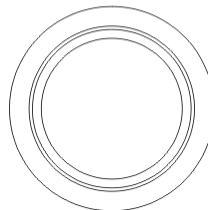
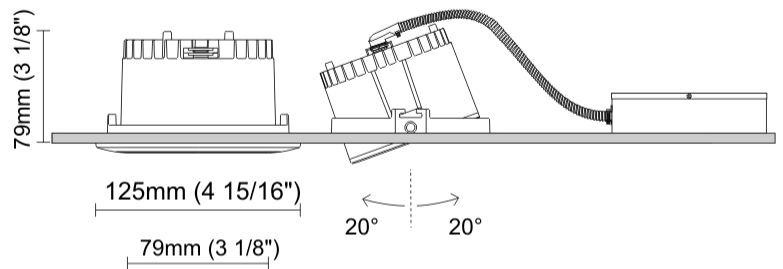

DIXIT RA11 RECESSED

A56024-

| | |
|-----------|--|
| PROJECT | |
| TYPE | |
| SPECIFIER | |
| QUANTITY | |
| DATE | |

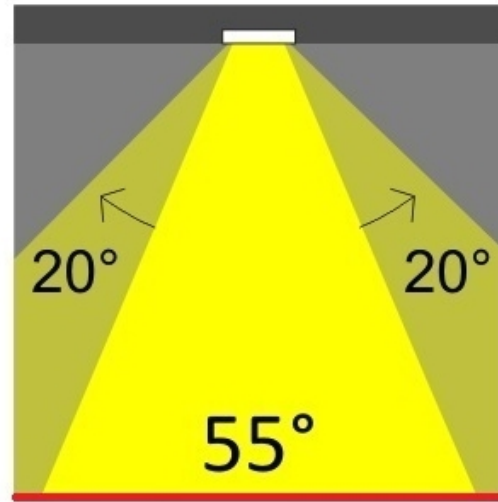
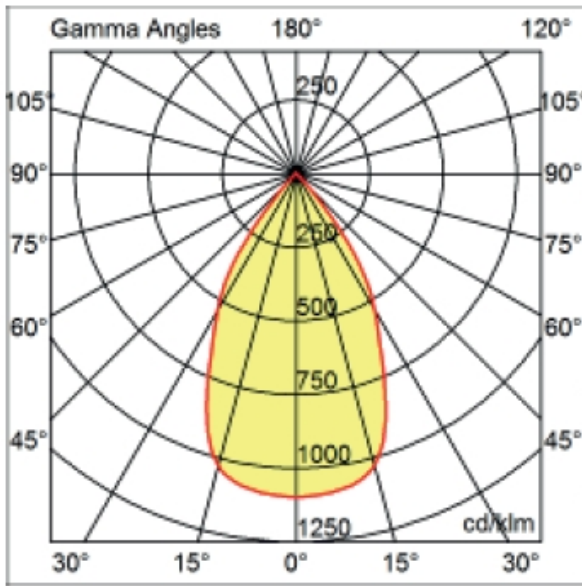

| | | | | |
|-------------------|-------|-------|-------|-------|
| | DP | DV | | |
| Dimming | Phase | 0-10V | | |
| Color Temperature | 27K | 30K | 35K | 40K |
| | 2700K | 3000K | 3500K | 4000K |

Order Example  **K°**
L5XXXXXX-DV-30K
 0-10V
 3000K



DIXIT RA11 RECESSED

A56028-

base number Color
Temperature

| | |
|-----------|-------|
| PROJECT | _____ |
| TYPE | _____ |
| SPECIFIER | _____ |
| QUANTITY | _____ |
| DATE | _____ |

- To build a product code in our configurator select the specify button on the base model # product page
- To build a manual product code on this datasheet choose from the options listed below in blue font and add the suffix to the base model #

GENERAL

Series: Dixit
Subseries: Dixit RA11
Brand: Ivela
Division: Architectural
Mounting Type: Recessed
Mounting Location: Ceiling
Subcategory: Downlight

PHYSICAL

Shape: Round
Diameter (mm): 126
Diameter (in): 4 15/16
Height (mm): 104
Height (in): 4 1/8
Min. Recessing Depth (mm): 144
Min. Recessing Depth (in): 5 11/16
Light Distribution: Direct
Weight (kg): 0.6
Weight (lbs): 1.32
Diffuser: Clear Polycarbonate
Fixture Finish: MWH
Fixture Material: Aluminum Die Cast
Cut-out Measurements: 122mm / 4 13/16"

ELECTRICAL

Lamp Type: LED
Total Output Wattage (W): 12 / 18 / 26
Dimming: Tri-Mode (Non-Dimming and Phase Dimming (120Vac only) and 0-10V Dimming)
Driver Included: No
Driver Location: Recessed Housing
Driver Type: Constant Current - Universal
Driver Class: Class 2
Input Voltage (V): 120 - 277
Constant Current (MA): 350 / 500 / 700

LED

Number of LEDs: 1
Color Temperature (°K): 2700 / 3000 / 4000
Max. Delivered Lumen (lm): 1513 - 1602 / 2092 - 2180 / 2759 - 2848
CRI: >85 CRI
Efficiency (%): 89
Lamp Life (hrs): 50000
Upon Request: 3500K upon request

OPTICAL

Optic°: 55
Adjustability: Fixed
Upon Request: Optic 18° or 30° (mirror-metallized) / 70° (white)

RATINGS AND CERTIFICATIONS

Certified By: Certified for North American Standards
IP rating: IP43
IK Rating: IK08
Glare Rating: ≤ 19

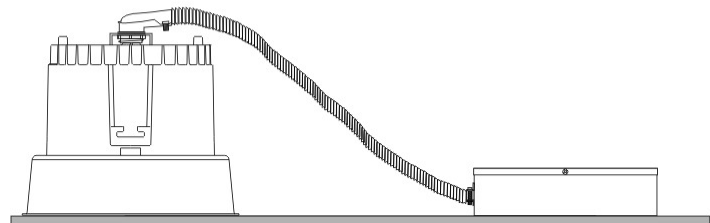
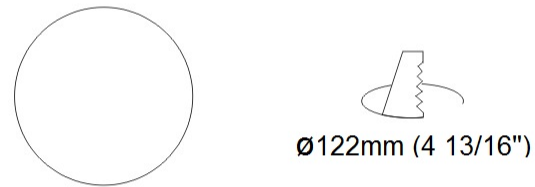
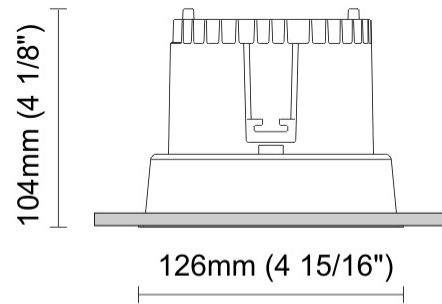



DIXIT RA11 RECESSED

A56028-

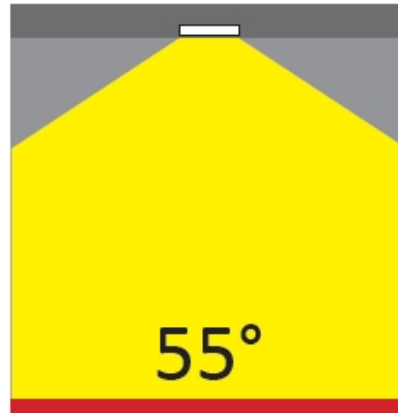
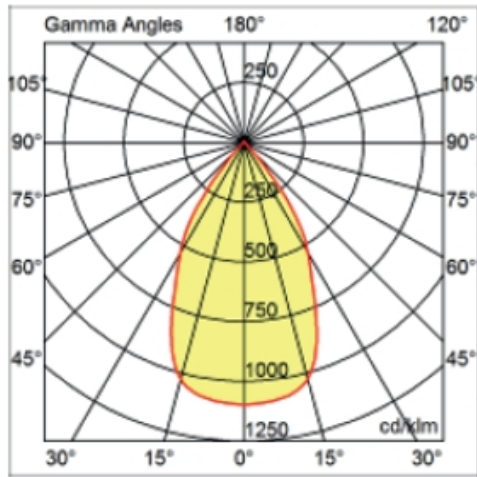
| | |
|-----------|--|
| PROJECT | |
| TYPE | |
| SPECIFIER | |
| QUANTITY | |
| DATE | |



| | | | | | |
|-------------------|--------------|--------------|---|---|-------|
| | DP | DV |  | Order Example  | K° |
| Dimming | Phase | 0-10V | | L5XXXXXX-DV-30K | |
| Color Temperature | 27K 2700K | 30K 3000K | 35K 3500K | 0-10V | 3000K |

A

DIXIT RA11 RECESSED

A56032-

base number Color
Temperature

| | |
|-----------|-------|
| PROJECT | _____ |
| TYPE | _____ |
| SPECIFIER | _____ |
| QUANTITY | _____ |
| DATE | _____ |

- To build a product code in our configurator select the specify button on the base model # product page
- To build a manual product code on this datasheet choose from the options listed below in blue font and add the suffix to the base model #

GENERAL

Series: Dixit
Subseries: Dixit RA11
Brand: Ivela
Division: Architectural
Mounting Type: Recessed
Mounting Location: Ceiling
Subcategory: Downlight

PHYSICAL

Shape: Round
Diameter (mm): 141
Diameter (in): 5 5/16
Height (mm): 117
Height (in): 4 5/8
Min. Recessing Depth (mm): 157
Min. Recessing Depth (in): 6 3/16
Light Distribution: Direct
Weight (kg): 0.7
Weight (lbs): 1.54
Diffuser: Clear Polycarbonate
Fixture Finish: MWH
Fixture Material: Aluminum Die Cast
Cut-out Measurements: 126mm / 4 15/16"

ELECTRICAL

Lamp Type: LED
Total Output Wattage (W): 12 / 18 / 26
Dimming: Tri-Mode (Non-Dimming and Phase Dimming (120Vac only) and 0-10V Dimming)
Driver Included: No
Driver Location: Recessed Housing
Driver Type: Constant Current - Universal
Driver Class: Class 2
Input Voltage (V): 120 - 277
Constant Current (MA): 350 / 500 / 700

LED

Number of LEDs: 1
Color Temperature (°K): 2700 / 3000
Max. Delivered Lumen (lm): 1513 / 2092
CRI: >85 CRI
Efficiency (%): 89
Lamp Life (hrs): 50000
Upon Request: 3500K upon request

OPTICAL

Optic°: 55
Adjustability: Fixed
Upon Request: Optic 12° or 30° (mirror-metallized) / 70° (white)

RATINGS AND CERTIFICATIONS

Certified By: CSA Certified to UL and CSA Standards
IP Rating: IP43
IK Rating: IK08
Glare Rating: ≤ 19

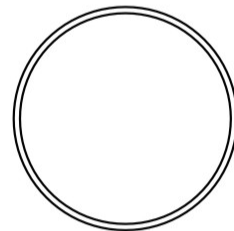
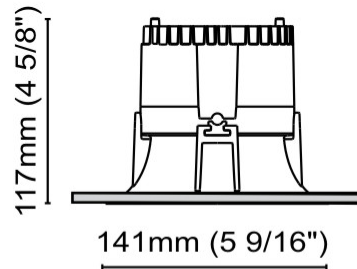

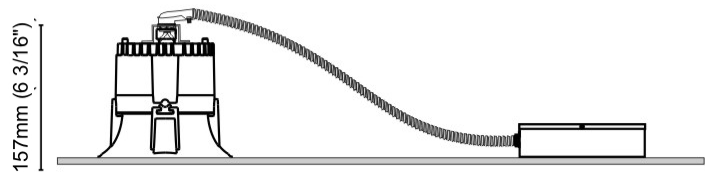

126mm (4 15/16")



DIXIT RA11 RECESSED

A56032-

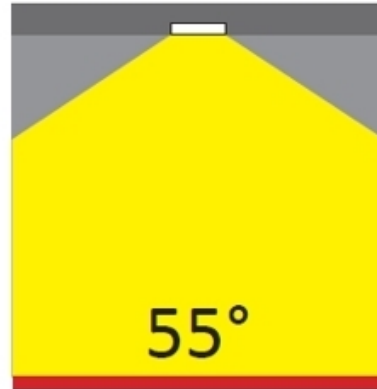
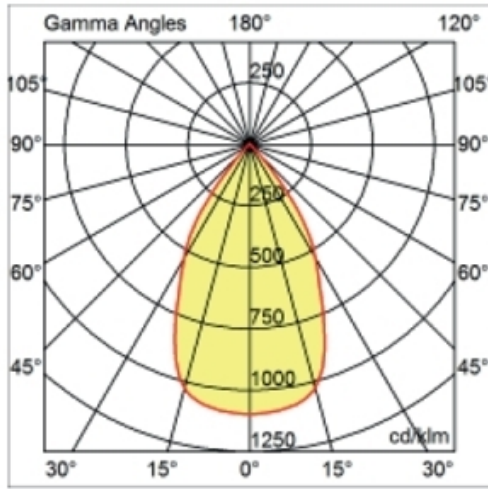
| | |
|-----------|--|
| PROJECT | |
| TYPE | |
| SPECIFIER | |
| QUANTITY | |
| DATE | |



| RA 11 DIXIT LED SOFT 12W 1700 lm 3000K | | | | | R:100% | | I.Max:1293 Cd/Klm | | | | |
|--|------|---------|---------|-----------|--------|------|-------------------|---------|---------|----------|--|
| H[m] | D[m] | Max lux | Med lux | Alpha=54° | | H[m] | D[m] | Max lux | Med lux | Beta=54° | |
| 1.00 | 1.02 | 1913 | 1003 | | | 1.00 | 1.02 | 1913 | 1003 | | |
| 2.00 | 2.04 | 478 | 251 | | | 2.00 | 2.04 | 478 | 251 | | |
| 3.00 | 3.06 | 213 | 111 | | | 3.00 | 3.06 | 213 | 111 | | |
| 4.00 | 4.08 | 120 | 63 | | | 4.00 | 4.08 | 120 | 63 | | |
| 5.00 | 5.10 | 77 | 40 | | | 5.00 | 5.10 | 77 | 40 | | |

| | | | |
|-------------------|-------|-------|-------|
| Dimming | DP | DV | |
| | Phase | 0-10V | |
| Color Temperature | 27K | 30K | 35K |
| | 2700K | 3000K | 3500K |

Order Example **K°**
L5XXXXXX-DV-30K
0-10V
3000K



DIXIT RA8 RECESSED

A56061-

base number _____ Color _____
 Temperature _____

- To build a product code in our configurator select the specify button on the base model # product page
- To build a manual product code on this datasheet choose from the options listed below in blue font and add the suffix to the base model #

GENERAL

Series: Dixit
 Subseries: Dixit RA8
 Brand: Ivela
 Division: Architectural
 Mounting Type: Recessed
 Mounting Location: Ceiling
 Subcategory: Downlight

PHYSICAL

Shape: Round
 Diameter (mm): 96
 Diameter (in): 3 3/4
 Height (mm): 85
 Height (in): 3 3/8
 Min. Recessing Depth (mm): 125
 Min. Recessing Depth (in): 4 15/16
 Light Distribution: Direct
 Weight (kg): 0.3
 Weight (lbs): 0.66
 Diffuser: Clear Polycarbonate
 Fixture Finish: MWH
 Fixture Material: Aluminum Die Cast
 Cut-out Measurements: 92mm / 3 5/8"

ELECTRICAL

Lamp Type: LED
 Total Output Wattage (W): 5.5 / 8.5
 Dimming: Tri-Mode (Non-Dimming and Phase Dimming (120Vac only) and 0-10V Dimming)
 Driver Included: No
 Driver Location: Recessed Housing
 Driver Type: Constant Current - Universal
 Driver Class: Class 2
 Input Voltage (V): 120 - 277
 Constant Current (MA): 350 / 500

LED

Number of LEDs: 1
 Color Temperature (°K): 2700 / 3000
 Max. Delivered Lumen (lm): 501 / 638
 CRI: >90 CRI
 Efficiency (%): 87.7
 Lamp Life (hrs): 50000
 Upon Request: 3500K upon request

OPTICAL

Optic°: 26
 Beam Angle: Symmetric
 Adjustability: Fixed
 Upon Request: Optic 45° (mirror-metallized) / 65° (white)

RATINGS AND CERTIFICATIONS

Certified By: Certified for North American Standards
 IP rating: IP44
 IK Rating: IK08

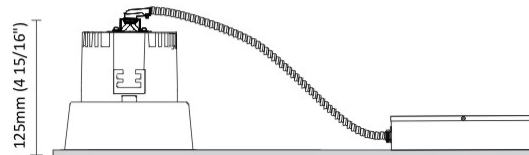
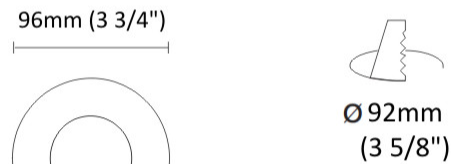
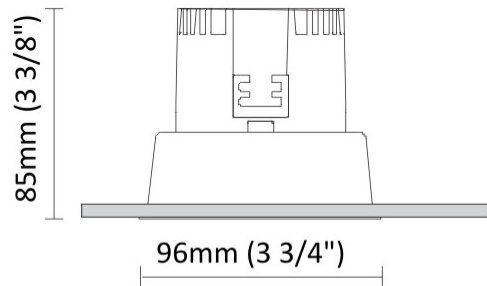

DIXIT RA8 RECESSED

A56061-

| | |
|-----------|--|
| PROJECT | |
| TYPE | |
| SPECIFIER | |
| QUANTITY | |
| DATE | |

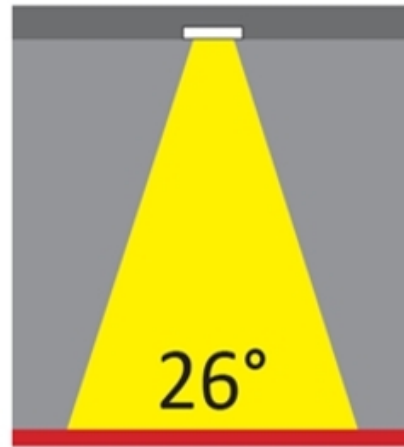
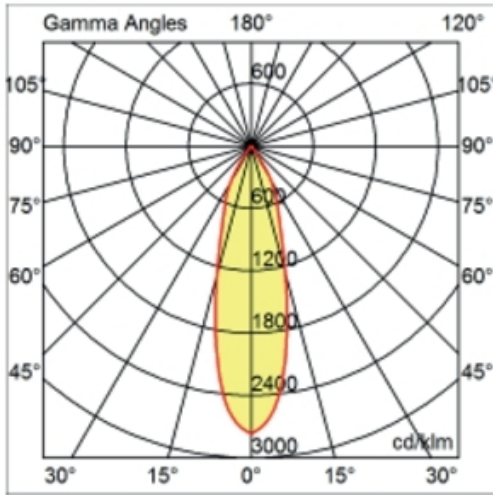

| RA 8 TL DIXIT LED 6.5W 550 lm | | | | R:100% | | | | I.Max:2958 Cd/Klm | | | |
|-------------------------------|------|---------|---------|-----------|--|------|------|-------------------|---------|----------|--|
| H[m] | D[m] | Max lux | Med lux | Alpha=26° | | H[m] | D[m] | Max lux | Med lux | Beta=26° | |
| 1.00 | 0.47 | 1508 | 939 | | | 1.00 | 0.47 | 1508 | 939 | | |
| 2.00 | 0.94 | 377 | 235 | | | 2.00 | 0.94 | 377 | 235 | | |
| 3.00 | 1.41 | 168 | 104 | | | 3.00 | 1.41 | 168 | 104 | | |
| 4.00 | 1.89 | 94 | 59 | | | 4.00 | 1.89 | 94 | 59 | | |
| 5.00 | 2.36 | 60 | 38 | | | 5.00 | 2.36 | 60 | 38 | | |

| | | | |
|-------------------|-------|-------|-------|
| Dimming | DP | DV | K° |
| | Phase | 0-10V | |
| Color Temperature | 27K | 30K | 35K |
| | 2700K | 3000K | 3500K |

Order Example **K°**
L5XXXXXX-DV-30K
 0-10V
 3000K



| | |
|-----------|-------|
| PROJECT | _____ |
| TYPE | _____ |
| SPECIFIER | _____ |
| QUANTITY | _____ |
| DATE | _____ |

DIXIT RA8 RECESSED

A56063-

base number _____
 Color _____
 Temperature _____

- To build a product code in our configurator select the specify button on the base model # product page
- To build a manual product code on this datasheet choose from the options listed below in blue font and add the suffix to the base model #

GENERAL

Series: Dixit
 Subseries: Dixit RA8
 Brand: Ivela
 Division: Architectural
 Mounting Type: Recessed
 Mounting Location: Ceiling
 Subcategory: Downlight

PHYSICAL

Shape: Round
 Diameter (mm): 96
 Diameter (in): 3 3/4
 Height (mm): 110
 Height (in): 4 5/16
 Min. Recessing Depth (mm): 150
 Min. Recessing Depth (in): 5 7/8
 Light Distribution: Direct
 Weight (kg): 0.4
 Weight (lbs): 0.88
 Diffuser: Clear Polycarbonate
 Fixture Finish: MWH
 Fixture Material: Aluminum Die Cast
 Cut-out Measurements: 92mm / 3 5/8"

ELECTRICAL

Lamp Type: LED
 Total Output Wattage (W): 9 / 12
 Dimming: Tri-Mode (Non-Dimming and Phase Dimming (120Vac only) and 0-10V Dimming)
 Driver Included: No
 Driver Location: Recessed Housing
 Driver Type: Constant Current - Universal
 Driver Class: Class 2
 Input Voltage (V): 120 - 277
 Constant Current (MA): 250 / 350

LED

Number of LEDs: 1
 Color Temperature (°K): 2700 / 3000
 Max. Delivered Lumen (lm): 1096 / 1447
 CRI: >80 CRI
 Efficiency (%): 87.7
 Lamp Life (hrs): 50000
 Upon Request: 3500K upon request

OPTICAL

Optic°: 26
 Beam Angle: Symmetric
 Adjustability: Fixed
 Upon Request: Optic 45° (mirror-metallized) / 65° (white)

RATINGS AND CERTIFICATIONS

Certified By: Certified for North American Standards
 IP rating: IP44
 IK Rating: IK08

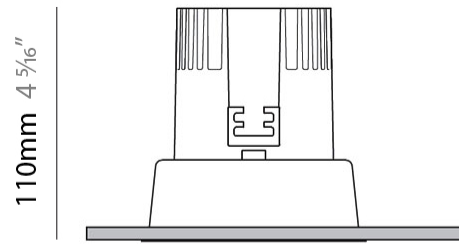

Ø96mm 3 3/4"

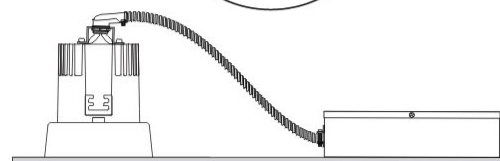
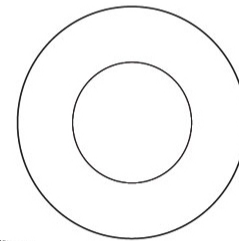

DIXIT RA8 RECESSED

A56063-

| | |
|-----------|--|
| PROJECT | |
| TYPE | |
| SPECIFIER | |
| QUANTITY | |
| DATE | |

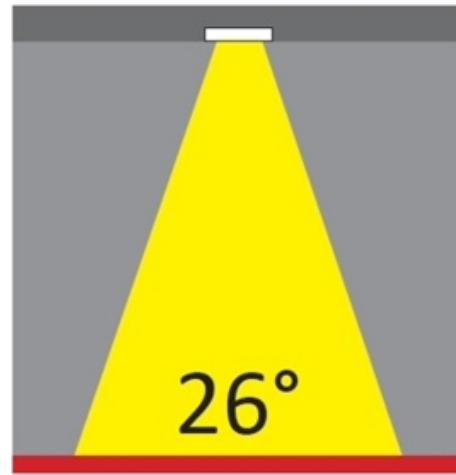
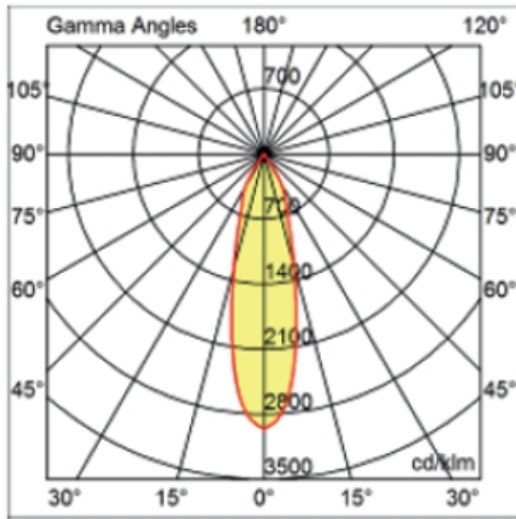

| | | | | | |
|-------------------|-------|-------|-------|-----------------|-------|
| | DP | DV | | Order Example | K° |
| Dimming | Phase | 0-10V | | L5XXXXXX-DV-30K | |
| Color Temperature | 27K | 30K | 35K | 0-10V | 3000K |
| | 2700K | 3000K | 3500K | | |



DIXIT RA8 RECESSED

A56069-

base number Color
Temperature

| | |
|-----------|-------|
| PROJECT | _____ |
| TYPE | _____ |
| SPECIFIER | _____ |
| QUANTITY | _____ |
| DATE | _____ |

- To build a product code in our configurator select the specify button on the base model # product page
- To build a manual product code on this datasheet choose from the options listed below in blue font and add the suffix to the base model #

GENERAL

Series: Dixit
Subseries: Dixit RA8
Brand: Ivela
Division: Architectural
Mounting Type: Recessed
Mounting Location: Ceiling
Subcategory: Downlight

PHYSICAL

Shape: Round
Diameter (mm): 80
Diameter (in): 3 1/8
Height (mm): 74
Height (in): 2 15/16
Min. Recessing Depth (mm): 114
Min. Recessing Depth (in): 4 1/2
Light Distribution: Direct
Weight (kg): 0.4
Weight (lbs): 0.88
Diffuser: Clear Polycarbonate
Fixture Finish: MWH
Fixture Material: Aluminum Die Cast
Cut-out Measurements: 70mm / 2 3/4"

ELECTRICAL

Lamp Type: LED
Total Output Wattage (W): 9 / 12
Dimming: Tri-Mode (Non-Dimming and Phase Dimming (120Vac only) and 0-10V Dimming)
Driver Included: No
Driver Location: Recessed Housing
Driver Type: Constant Current - Universal
Driver Class: Class 2
Input Voltage (V): 120 - 277
Constant Current (MA): 250 / 350

LED

Number of LEDs: 1
Color Temperature (°K): 2700 / 3000
Max. Delivered Lumen (lm): 1096 / 1447
CRI: >80 CRI
Efficiency (%): 88
Lamp Life (hrs): 50000
Upon Request: 3500K upon request

OPTICAL

Optic°: 26
Adjustability: Fixed
Upon Request: Optic 45° (mirror-metallized) / 65° (white)

RATINGS AND CERTIFICATIONS

Certified By: Certified for North American Standards
IP rating: IP44
IK Rating: IK08
Glare Rating: ≤ 19

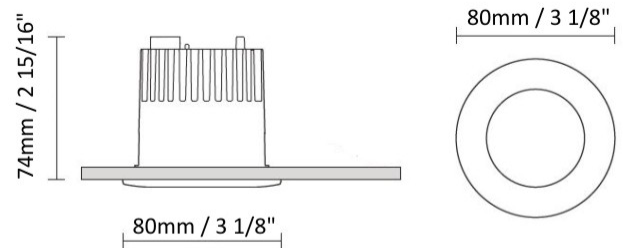

Ø 70mm (2 3/4")

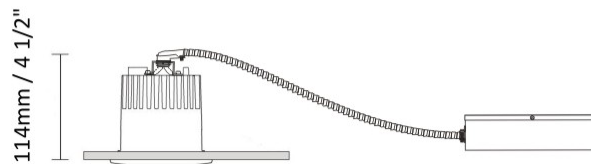

DIXIT RA8 RECESSED

A56069-

| | |
|-----------|--|
| PROJECT | |
| TYPE | |
| SPECIFIER | |
| QUANTITY | |
| DATE | |

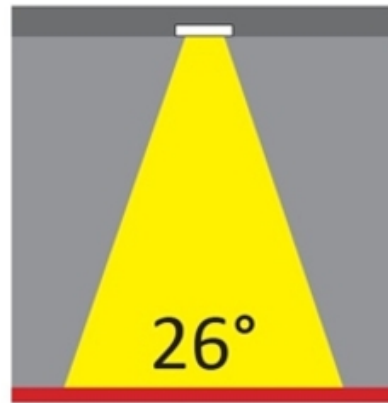
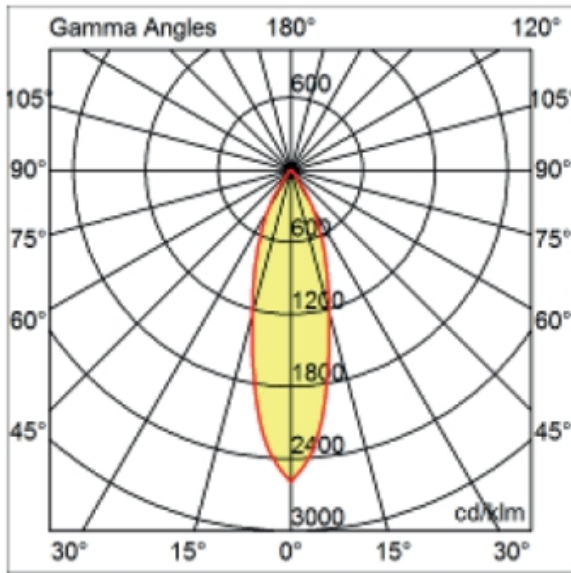

| | | | |
|-------------------|-----------|-----------|---------------------|
| | DP | DV | |
| Dimming | Phase | 0-10V | |
| Color Temperature | 27K 2700K | 30K 3000K | 35K 3500K 40K 4000K |

Order Example  **K°**
L5XXXXXX-DV-30K
 0-10V 3000K



DIXIT RA8 RECESSED

A56077-

base number _____ Color _____
 Temperature _____

- To build a product code in our configurator select the specify button on the base model # product page
- To build a manual product code on this datasheet choose from the options listed below in blue font and add the suffix to the base model #

GENERAL

Series: Dixit
 Subseries: Dixit RA8
 Brand: Ivela
 Division: Architectural
 Mounting Type: Recessed
 Mounting Location: Ceiling
 Subcategory: Downlight

PHYSICAL

Shape: Round
 Diameter (mm): 103
 Diameter (in): 4 1/16
 Height (mm): 85
 Height (in): 3 3/8
 Min. Recessing Depth (mm): 125
 Min. Recessing Depth (in): 4 15/16
 Light Distribution: Direct
 Weight (kg): 0.3
 Weight (lbs): 0.66
 Diffuser: Clear Polycarbonate
 Fixture Finish: MWH
 Fixture Material: Aluminum Die Cast
 Cut-out Measurements: 96mm / 3 3/4"

ELECTRICAL

Lamp Type: LED
 Total Output Wattage (W): 9 / 12
 Dimming: Tri-Mode (Non-Dimming and Phase Dimming (120Vac only) and 0-10V Dimming)
 Driver Included: No
 Driver Location: Recessed Housing
 Driver Type: Constant Current - Universal
 Driver Class: Class 2
 Input Voltage (V): 120 - 277
 Constant Current (MA): 250 / 350

LED

Number of LEDs: 1
 Color Temperature (°K): 2700 / 3000
 Max. Delivered Lumen (lm): 1096 / 1447
 CRI: >90 CRI
 Efficiency (%): 73
 Lamp Life (hrs): 50000
 Upon Request: 3500K upon request

OPTICAL

Optic°: 26
 Adjustability: Fixed

RATINGS AND CERTIFICATIONS

Certified By: Certified for North American Standards
 IP rating: IP43

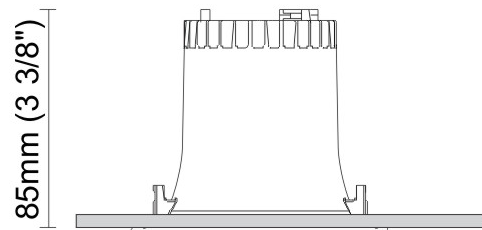

103mm (4 1/16")

103mm (4 1/16")

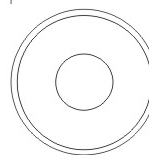

Ø96mm
(3 3/4")

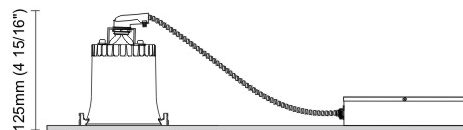



DIXIT RA8 RECESSED

A56077-

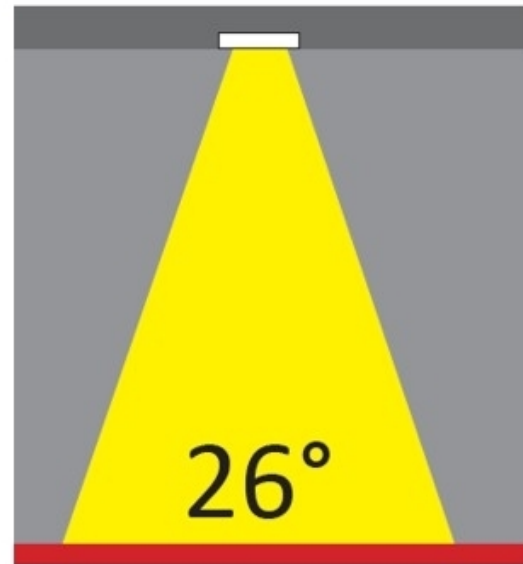
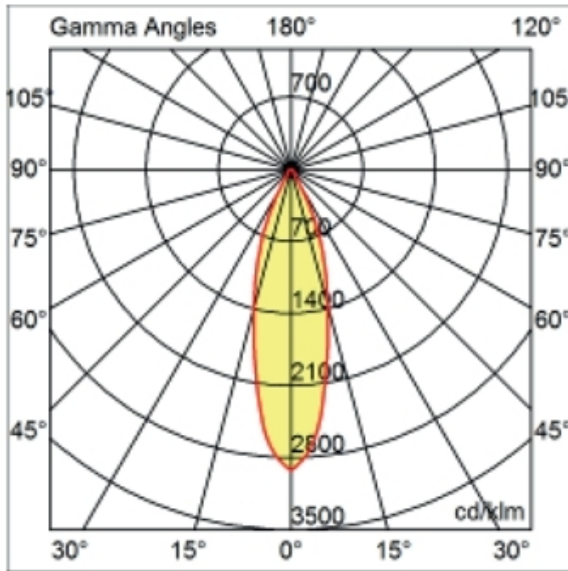
| | |
|-----------|--|
| PROJECT | |
| TYPE | |
| SPECIFIER | |
| QUANTITY | |
| DATE | |



| | | | |
|-------------------|-------|-------|-------|
| | DP | DV | |
| Dimming | Phase | 0-10V | |
| Color Temperature | 27K | 30K | 35K |
| | 2700K | 3000K | 3500K |

Order Example  **K°**
L5XXXXXX-DV-30K
 **0-10V**
3000K

A

DIXIT RA14 RECESSED

A56093-

base number _____ Color _____
 Temperature _____

- To build a product code in our configurator select the specify button on the base model # product page
- To build a manual product code on this datasheet choose from the options listed below in blue font and add the suffix to the base model #

GENERAL

Series: Dixit
 Subseries: Dixit RA14
 Brand: Ivela
 Division: Architectural
 Mounting Type: Recessed
 Mounting Location: Ceiling
 Subcategory: Downlight

PHYSICAL

Shape: Round
 Diameter (mm): 140
 Diameter (in): 5 1/2
 Height (mm): 92
 Height (in): 3 5/8
 Min. Recessing Depth (mm): 132
 Min. Recessing Depth (in): 5 3/16
 Light Distribution: Direct
 Weight (kg): 0.7
 Weight (lbs): 1.54
 Diffuser: Clear Polycarbonate
 Fixture Finish: MWH
 Fixture Material: Aluminum Die Cast
 Cut-out Measurements: 126mm / 4 15/16"

ELECTRICAL

Lamp Type: LED
 Total Output Wattage (W): 26 / 33 / 38
 Dimming: Tri-Mode (Non-Dimming and Phase Dimming (120Vac only) and 0-10V Dimming)
 Driver Included: No
 Driver Location: Recessed Housing
 Driver Type: Constant Current - Universal
 Driver Class: Class 2
 Input Voltage (V): 120 - 277
 Constant Current (MA): 700 / 900 / 1050

LED

Number of LEDs: 1
 Color Temperature (°K): 2700 / 3000 / 4000
 Max. Delivered Lumen (lm): 2924 - 3100 / 3655 - 3748 / 4214 - 4300
 CRI: >85 CRI
 Efficiency (%): 86
 Lamp Life (hrs): 50000
 Upon Request: 3500K

OPTICAL

Optic°: 60
 Beam Angle: Symmetric
 Adjustability: Fixed

RATINGS AND CERTIFICATIONS

Certified By: CSA Certified to UL and CSA Standards
 IP Rating: IP44
 IK Rating: IK08

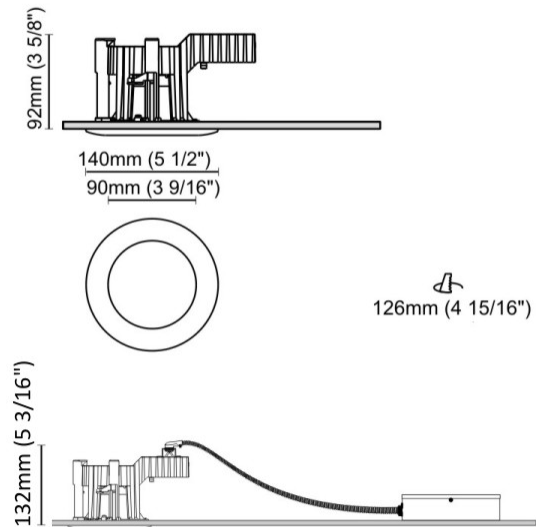
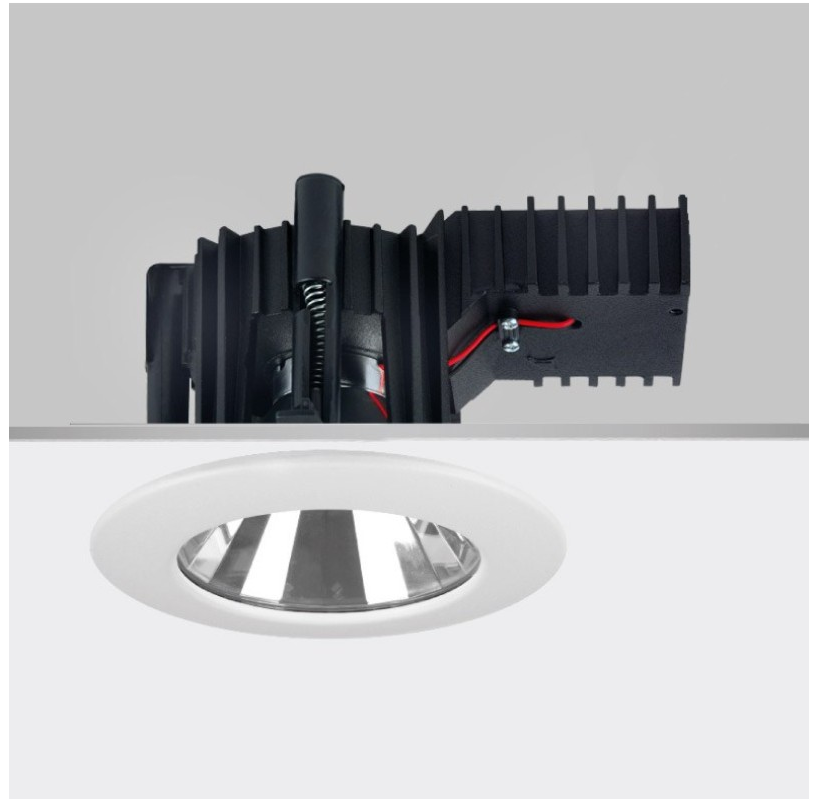

DIXIT RA14 RECESSED

A56093-

| | |
|-----------|--|
| PROJECT | |
| TYPE | |
| SPECIFIER | |
| QUANTITY | |
| DATE | |

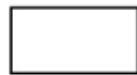
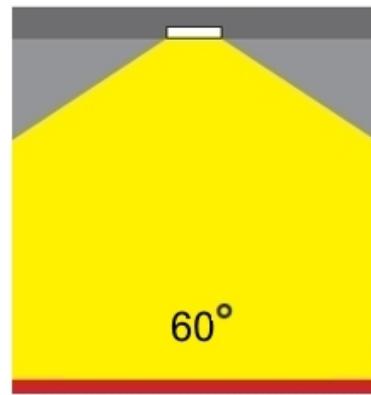
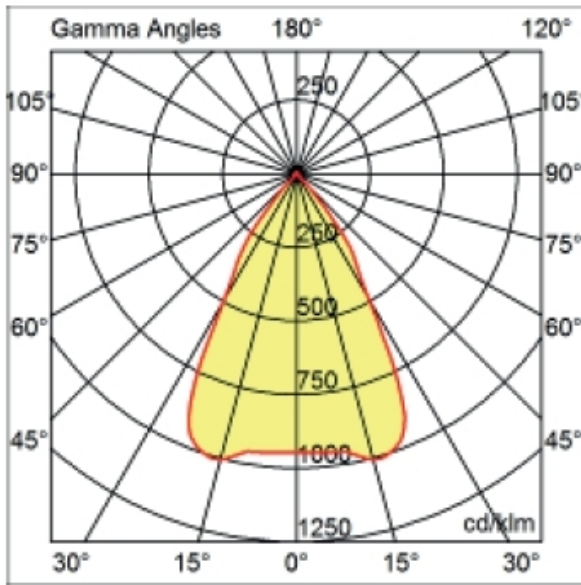

Matte White



Silver

| | | | | |
|-------------------|-------|-------|-------|-------|
| | DP | DV | | |
| Dimming | Phase | 0-10V | | |
| Color Temperature | 27K | 30K | 35K | 40K |
| | 2700K | 3000K | 3500K | 4000K |

Order Example  **K°**
L5XXXXXX-DV-30K
 0-10V
 3000K



| | |
|-----------|-------|
| PROJECT | _____ |
| TYPE | _____ |
| SPECIFIER | _____ |
| QUANTITY | _____ |
| DATE | _____ |

DIXIT RA16 RECESSED

A56102-

base number _____
 Color _____
 Temperature _____

- To build a product code in our configurator select the specify button on the base model # product page
- To build a manual product code on this datasheet choose from the options listed below in blue font and add the suffix to the base model #

GENERAL

Series: Dixit
 Subseries: Dixit RA16
 Brand: Ivela
 Division: Architectural
 Mounting Type: Recessed
 Mounting Location: Ceiling
 Subcategory: Downlight

PHYSICAL

Shape: Round
 Diameter (mm): 160
 Diameter (in): 6 5/16
 Height (mm): 42
 Height (in): 1 5/8
 Min. Recessing Depth (mm): 82
 Min. Recessing Depth (in): 3 1/4
 Light Distribution: Direct
 Weight (kg): 0.7
 Weight (lbs): 15.43
 Diffuser: Polycarbonate - Opal
 Fixture Finish: MWH
 Fixture Material: Aluminum Die Cast
 Cut-out Measurements: 155mm / 6 1/8"

ELECTRICAL

Lamp Type: LED
 Total Output Wattage (W): 18
 Dimming: Tri-Mode (Non-Dimming and Phase Dimming (120Vac only) and 0-10V Dimming)
 Driver Included: No
 Driver Location: Recessed Housing
 Driver Type: Constant Current - Universal
 Driver Class: Class 2
 Input Voltage (V): 120 - 277
 Constant Current (MA): 500

LED

Number of LEDs: 1
 Color Temperature (°K): 2700 / 3000 / 3500 / 4000
 Max. Delivered Lumen (lm): 1745 / 1781
 CRI: >85 CRI
 Efficiency (%): 72.7
 Lamp Life (hrs): 50000

OPTICAL

Optic°: 110
 Beam Angle: Symmetric
 Adjustability: Fixed

RATINGS AND CERTIFICATIONS

Certified By: Certified for North American Standards
 IP rating: IP44
 IK Rating: IK07

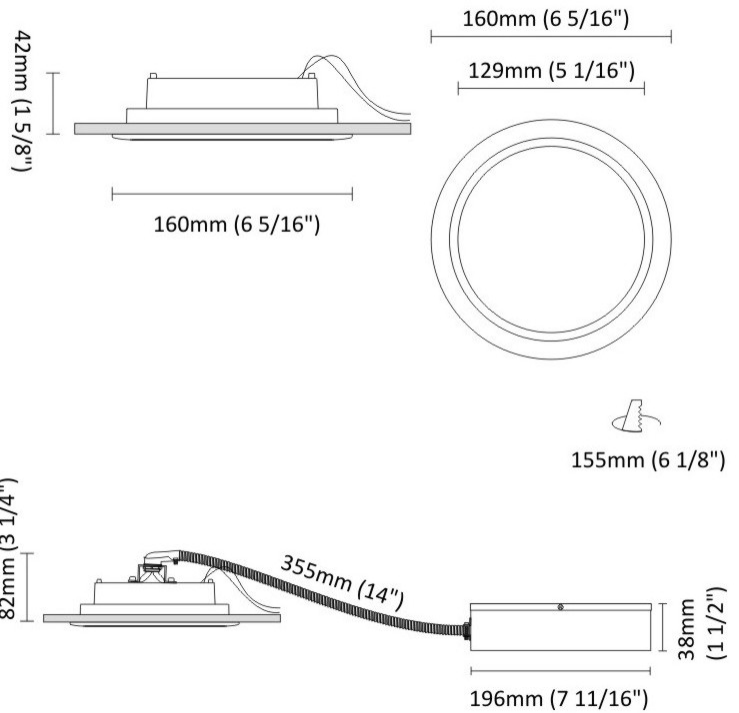

DIXIT RA16 RECESSED

A56102-

| | |
|-----------|--|
| PROJECT | |
| TYPE | |
| SPECIFIER | |
| QUANTITY | |
| DATE | |

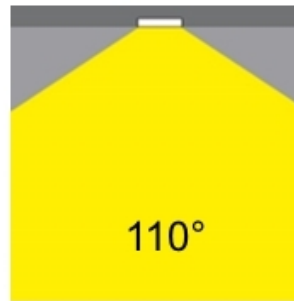
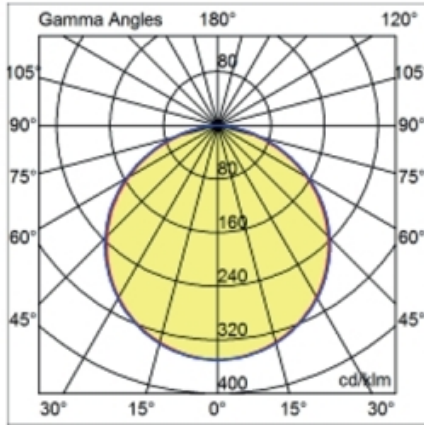

| RA 16 LED 18W 2400 lm | | | | R:100% | | | | I.Max:350 Cd/Klm | | | |
|-----------------------|-------|---------|---------|------------|------|-------|---------|------------------|-----------|--|--|
| H[m] | D[m] | Max lux | Med lux | Alpha=112° | H[m] | D[m] | Max lux | Med lux | Beta=113° | | |
| 1.00 | 2.99 | 604 | 145 | | 1.00 | 3.07 | 604 | 145 | | | |
| 2.00 | 5.98 | 151 | 36 | | 2.00 | 6.13 | 151 | 36 | | | |
| 3.00 | 8.96 | 67 | 16 | | 3.00 | 9.20 | 67 | 16 | | | |
| 4.00 | 11.95 | 38 | 9 | | 4.00 | 12.26 | 38 | 9 | | | |
| 5.00 | 14.94 | 24 | 6 | | 5.00 | 15.33 | 24 | 6 | | | |

| | | | | |
|-------------------|-------|-------|-------|-------|
| Dimming | DP | DV | | |
| | Phase | 0-10V | | |
| Color Temperature | 27K | 30K | 35K | 40K |
| | 2700K | 3000K | 3500K | 4000K |

Order Example **K°**

L5XXXXXX-DV-30K

0-10V

3000K



DIXIT RA23 RECESSED

A56112-

base number Color
Temperature

1. To build a product code in our configurator select the specify button on the base model # product page
2. To build a manual product code on this datasheet choose from the options listed below in blue font and add the suffix to the base model #

GENERAL

Series: Dixit
Subseries: Dixit RA23
Brand: Ivela
Division: Architectural
Mounting Type: Recessed
Mounting Location: Ceiling
Subcategory: Downlight

PHYSICAL

Shape: Round
Diameter (mm): 235
Diameter (in): 9 1/4
Height (mm): 155
Height (in): 6 1/8
Min. Recessing Depth (mm): 155
Min. Recessing Depth (in): 6 1/8
Light Distribution: Direct
Weight (kg): 3.6
Weight (lbs): 7.93
Diffuser: Tempered Safety glass 4mm / 5/32"
Fixture Finish: MWH
Fixture Material: Aluminum Die Cast
Cut-out Measurements: 220mm / 8 5/8"

ELECTRICAL

Lamp Type: LED
Total Output Wattage (W): 51
Dimming: Tri-Mode (Non-Dimming and Phase Dimming (120Vac only) and 0-10V Dimming)
Driver Included: No
Driver Location: Recessed Housing
Driver Type: Constant Current - Universal
Driver Class: Class 2
Housing: See Components
Input Voltage (V): 120 - 277
Constant Current (MA): 1400

LED

Number of LEDs: 1
Color Temperature (*K): 2700 / 3000 / 4000
Max. Delivered Lumen (lm): 5711 / 5827 / 5878 / 5998
CRI: >80 CRI
Efficiency (%): 85.7
Lamp Life (hrs): 50000
Upon Request: 3500K upon request

OPTICAL

Optic°: 100
Beam Angle: Symmetric
Adjustability: Fixed

RATINGS AND CERTIFICATIONS

Certified By: CSA Certified to UL and CSA Standards
IP rating: IP44
IK Rating: IK07

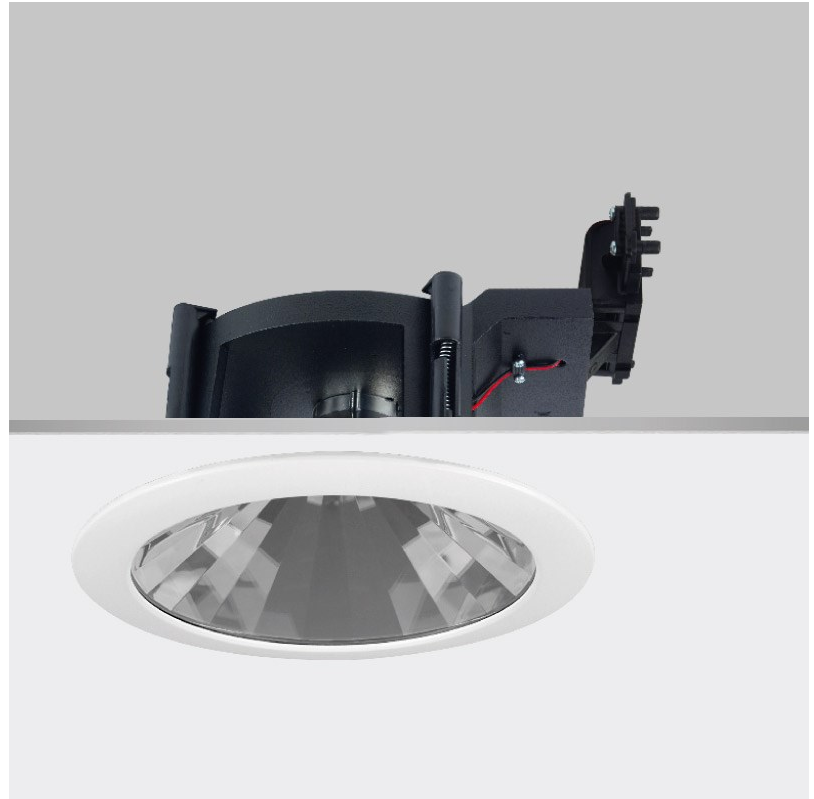

| | |
|-----------|--|
| PROJECT | |
| TYPE | |
| SPECIFIER | |
| QUANTITY | |
| DATE | |

DIXIT RA8 RECESSED

A56121-

base number Color
Temperature

- To build a product code in our configurator select the specify button on the base model # product page
- To build a manual product code on this datasheet choose from the options listed below in blue font and add the suffix to the base model #

GENERAL

Series: Dixit
Subseries: Dixit RA8
Brand: Ivela
Division: Architectural
Mounting Type: Recessed
Mounting Location: Ceiling
Subcategory: Downlight

PHYSICAL

Shape: Round
Diameter (mm): 80
Diameter (in): 3 1/8
Height (mm): 50
Height (in): 1 15/16
Min. Recessing Depth (mm): 90
Min. Recessing Depth (in): 3 9/16
Light Distribution: Direct
Weight (kg): 0.4
Weight (lbs): 0.88
Diffuser: Clear Polycarbonate
Fixture Finish: MWH
Fixture Material: Aluminum Die Cast
Cut-out Measurements: 70mm / 2 3/4"

ELECTRICAL

Lamp Type: LED
Total Output Wattage (W): 5.5 / 8.5
Dimming: Tri-Mode (Non-Dimming and Phase Dimming (120Vac only) and 0-10V Dimming)
Driver Included: No
Driver Location: Recessed Housing
Driver Type: Constant Current - Universal
Driver Class: Class 2
Input Voltage (V): 120 - 277
Constant Current (mA): 350 / 500

LED

Number of LEDs: 1
Color Temperature (°K): 2700 / 3000 / 3500 / 4000
Max. Delivered Lumen (lm): 501 / 638
CRI: >90 CRI
Efficiency (%): 91
Lamp Life (hrs): 50000

OPTICAL

Reflector: Mirror-metallized thermoplastic material
Optic: 26
Beam Angle: Symmetric
Adjustability: Fixed
Upon Request: Optic 45° (mirror-metallized) / 65° (white)

RATINGS AND CERTIFICATIONS

Certified By: CSA Certified to UL and CSA Standards
IP rating: IP44
IK Rating: IK08

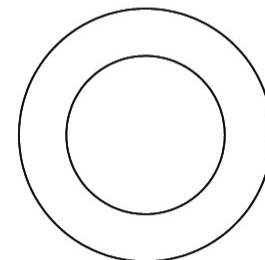
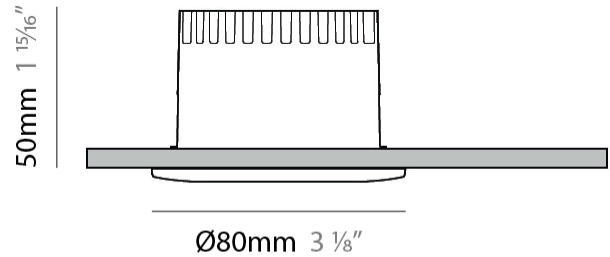



DIXIT RA8 RECESSED

A56121-

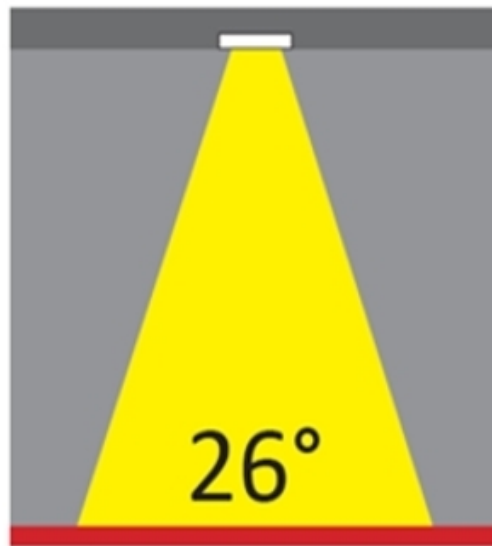
| |
|-----------|
| PROJECT |
| TYPE |
| SPECIFIER |
| QUANTITY |
| DATE |



| | | | | | | |
|-------------------|-------|-------|---|------------------------|---|-------|
| | DP | DV |  | Order Example |  | K° |
| Dimming | Phase | 0-10V | | L5XXXXXX-DV-30K | | |
| Color Temperature | 27K | 30K | 35K | 40K | | K° |
| | 2700K | 3000K | 3500K | 4000K | 0-10V | 3000K |

A

PROJECT

TYPE

SPECIFIER

QUANTITY

DATE

Fixture Finish

Matte White - MWH



Digital: Not all screens are calibrated the same, and therefore, colors will appear differently between screens.

Physical: When texture is involved, there will be variations in color, character and tone within a product series and between product families.



| | |
|-----------|--|
| PROJECT | |
| TYPE | |
| SPECIFIER | |
| QUANTITY | |
| DATE | |

LEGEND

| | | | | | |
|--|---|--|--|--|--|
| | floor-mounted | | pivotal | | special LED (upon request) RGB, RGBW, tunable, gold+, meat+, art+, fashion+ |
| | wall and ceiling: recessed and surface mounted | | rotating | | warm dim / natural dimming LED |
| | ceiling-mounted and wall-mounted | | illuminate tilted | | rechargeable battery powered |
| | wall-mounted | | color of suspension cable | | fixture with natural vivid LED (upon request) |
| | omni-directional light distribution | | length of suspension cable | | color rendering index |
| | direct light distribution | | reflector degree selection | | color temperature |
| | direct/indirect light distribution | | super spot | | lumen (luminous flux) |
| | indirect light distribution | | lens | | efficacy (lumens per watt) |
| | asymmetric light distribution | | lens pack | | Unified Glare Rating (UGR) range from 5-40 |
| | aura light distribution | | shine ring | | marine grade (AISI 316 stainless steel) |
| | round wall or ceiling cut-out | | integrated shine ring with diffuser | | walk on |
| | square wall or ceiling cut-out | | free individual colors 01-29 | | drive on |
| | the supplied jig specifies the cutout dimensions | | individual colors: 00 (free of charge), 01-25 (extra charge) | | Dark Sky Compliance |
| | minimum distance (meters) lamp - object | | luminaire part to be colored (F1) | | Americans with Disabilities Act (less than 4" off the wall located between 27"-84" from floor) |
| | recessed depth | | luminaire part to be colored (F2) | | lamp protected against explosion |
| | ceiling thickness in mm | | luminaire part to be colored (F3) | | blown glass using traditional methods by master glass blower |
| | ceiling thickness selection | | luminaire part to be colored (F4) | | acoustic material |
| | dimmable DP (phase), DV (0-10V), DD (dali), DS (step-dim) | | luminaire part to be colored (F5) | | protection class I, protection insulation |
| | included or excluded LED driver/transformer/control gear | | color of 3-circuit adaptor | | protection class II, protection insulation |
| | separately switchable | | indirect diffuser | | ETL Certified to UL and CSA Standards |
| | sensor | | direct diffuser | | UL Certified to UL and CSA Standards |
| | remote control | | ball-proof (upon request) | | CSA Certified to UL and CSA Standards |
| | available upon request | | accessory | | Certified for North American Standards |

IP RATING

| | |
|--|--|
| | protected against ingress of solid bodies greater than 12.5mm (finger) |
| | protected against ingress of solid bodies greater than 2.5mm protected against sprays of water up to 60 degrees from the vertical (rain) |
| | protected against ingress of solid bodies greater than 1mm (wire) no protection against the ingress of moisture |
| | protected against ingress of solid bodies greater than 1mm (wire) protected against sprays of water up to 60 degrees from the vertical (rain) |
| | protected against ingress of solid bodies greater than 1mm (wire) protected against water splashed from all directions |
| | protected against limited ingress of dust (wet rooms/covered outdoor areas) protected against water splashed from all directions |
| | protected against ingress of dust protected against jets of water |
| | protected against ingress of dust protected against powerful jets of water or heavy seas |
| | protected against ingress of dust protected against immersion of water between 15cm - 1m for 30 minutes |
| | protected against ingress of dust protected against immersion of water under pressure for long periods |

IK RATING

| | |
|--|---|
| | protected against 0.14 joules impact (equivalent to 0.25kg mass dropped from 56mm above the surface) |
| | protected against 0.2 joules impact (equivalent to 0.25kg mass dropped from 80mm above the surface) |
| | protected against 0.35 joules impact (equivalent to 0.25kg mass dropped from 140mm above the surface) |
| | protected against 0.5 joules impact (equivalent to 0.25kg mass dropped from 200mm above the surface) |
| | protected against 0.7 joules impact (equivalent to 0.25kg mass dropped from 280mm above the surface) |
| | protected against 1 joules impact (equivalent to 0.25kg mass dropped from 400mm above the surface) |
| | protected against 2 joules impact (equivalent to 0.5kg mass dropped from 400mm above the surface) |
| | protected against 5 joules impact (equivalent to 1.7kg mass dropped from 300mm above the surface) |
| | protected against 10 joules impact (equivalent to 5.0kg mass dropped from 200mm above the surface) |
| | protected against 20 joules impact (equivalent to 5.0kg mass dropped from 400mm above the surface) |